

# PUZ PLAN URBANISTIC ZONAL

## JUDETUL CONSTANTA - MUNICIPIUL CONSTANTA

### PLANSĂ 3 - REGLEMENTARI URBANISTICE - VARIANTA 2

#### - DETALIU CAI DE COMUNICATIE

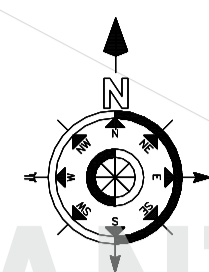
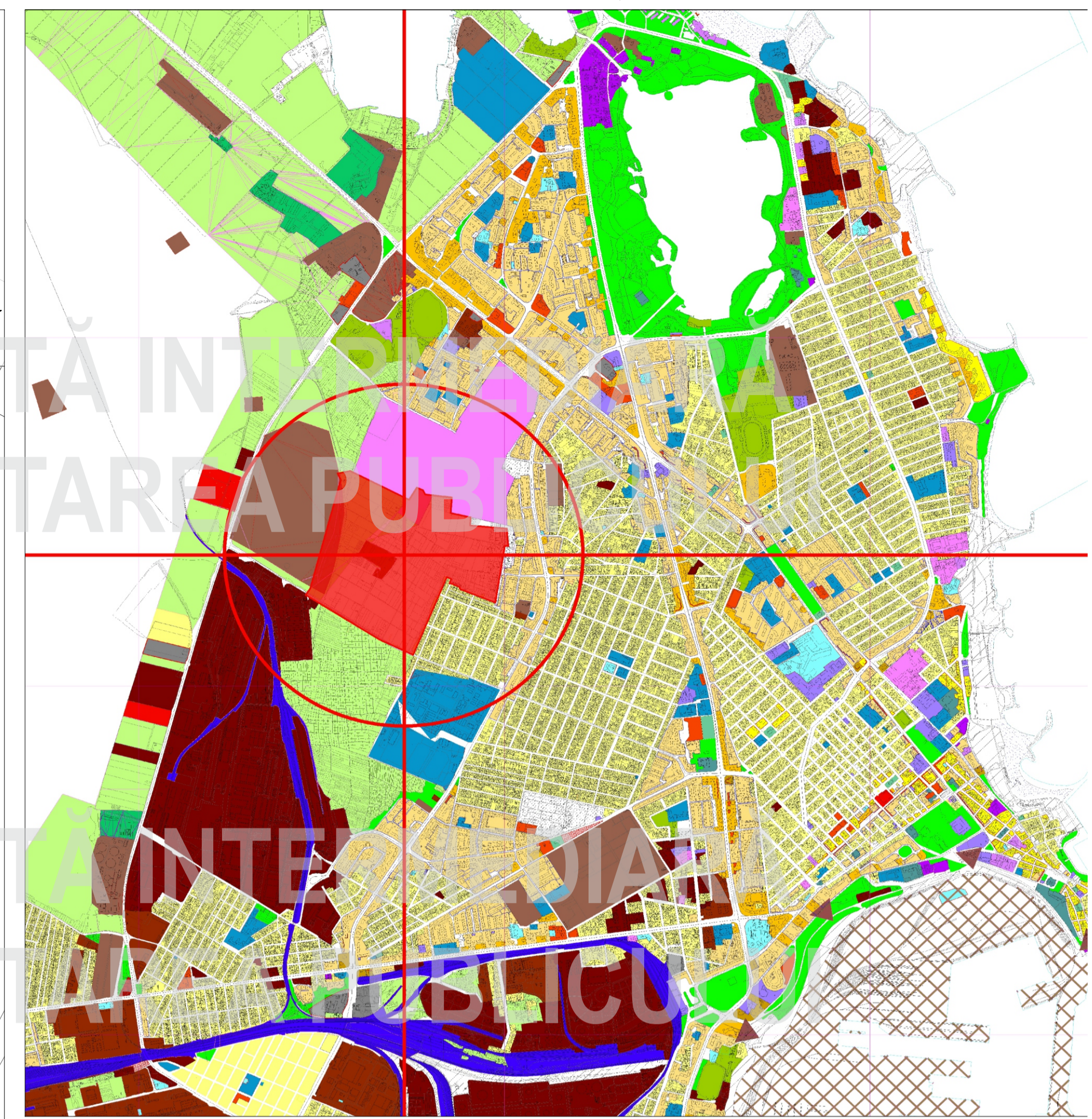

#### LEGENDA

- LIMITA DE STUDIU
- LIMITA CD PROPRIETATD
- Zone functionale**
- CIRCULATII CAROSABILE
- CIRCULATII PIETONALE
- PISTE VELO
- SENSURI DE CIRCULATIE

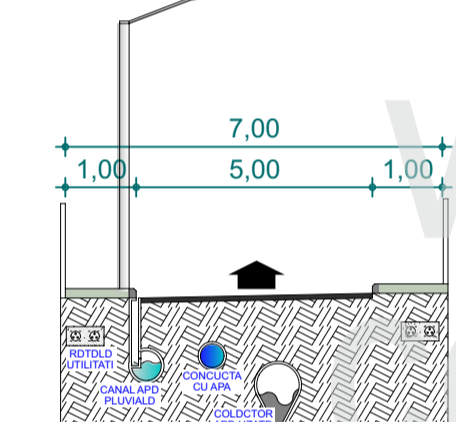

**SECTIUNE A - A'**  
\* SD APLICA PDNTRU TOATE STRAZILE CU SENS UNIC  
EXCPTAND STR. BABA NOVAC SI STR. B.S. DELAVRANCEA

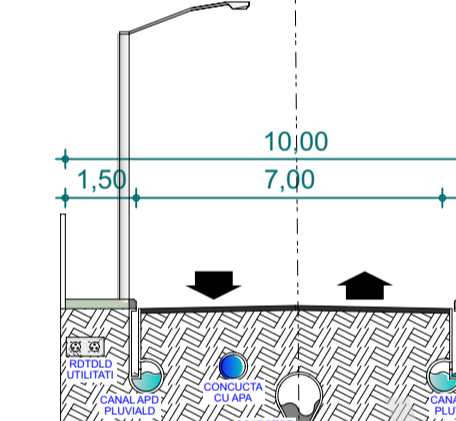

**SECTIUNE B - B'**

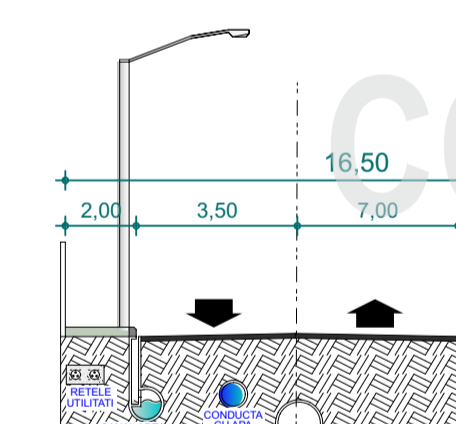

**SECTIUNE C - C'**

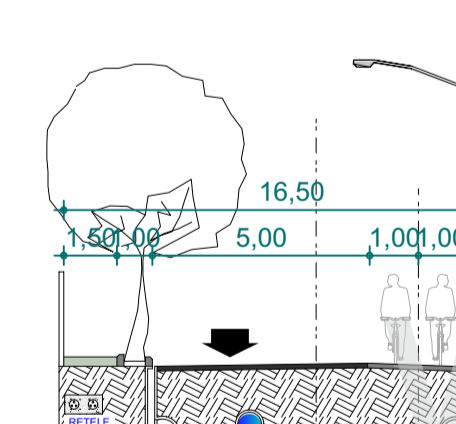

**SECTIUNE D - D'**

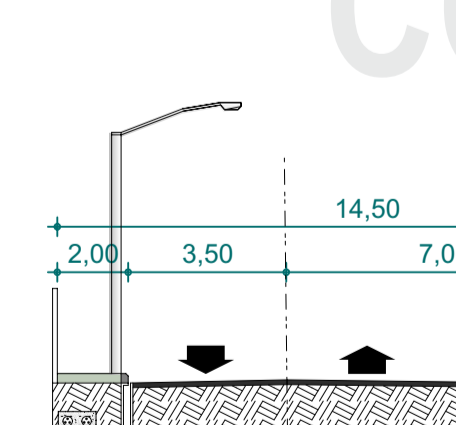

**SECTIUNE E - E'**

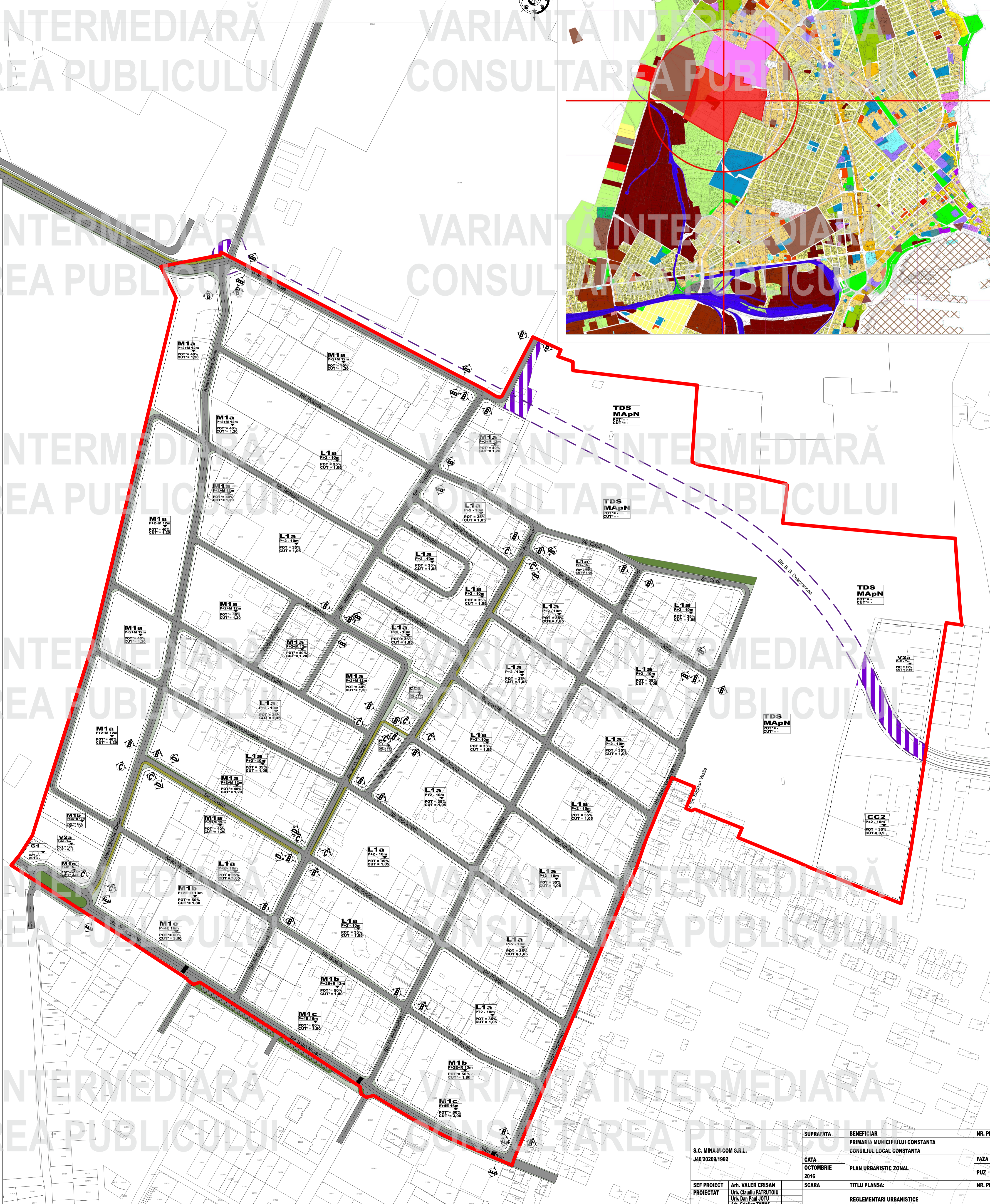

S.C. MINA-RO-COM S.R.L.		SUPRAFATA		BENEFICIAR		NR. PROIECT	
J40/2020/1992		CATA		PRIMARIA MUNICIPIULUI CONSTANTA		FAZA	
OCTOMBRIE 2016		SCARA		CONSILIUL LOCAL CONSTANTA		PUZ	
SEF PROIECT		1:2000		TITLU PLANSĂ:		NR. PLANSĂ	
PROIECTAT		Arh. VALER CRISAN		REGLEMENTARI URBANISTICE		02	
DESENAT		Ur. Claudiu PATRUTOIU		CAI DE COMUNICATIE			
		Ur. Dan Paul JOTU		VARIANTA 2			
		Arh. Cristina TAMAS					
		Ur. Valer CRISAN					
		Ur. Lorin TAGA					